

PE1 PELLET

PELLET BOILER



UNIQUE. INNOVATIVE.

Condensing technology
for pellet boilers

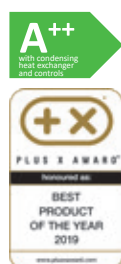

BETTER HEATING

INNOVATIVE AND
COMFORTABLE

froling 



ENVIRONMENTALLY
RESPONSIBLE HEATING,
ECONOMICALLY ATTRACTIVE



The price changes for different energy sources in recent years show the benefits of wood pellets: the ecological way of heating is also economically attractive. Wood is a renewable energy source that is also CO₂-neutral. Pellets are made of natural wood. The large volumes of wood shavings and sawdust generated by the wood-processing

industry are compacted and pelleted without being treated beforehand. Pellets have a high energy output and are easy to deliver and store. These are just some of the advantages that make pellets the perfect fuel for fully automatic heating systems. Pellets are delivered by tanker and unloaded directly into your store.

For almost sixty years Froling has specialised in the efficient use of wood as a source of energy. Today the name Froling stands for modern biomass heating technology. Froling firewood, wood chip and pellet boilers are successfully in operation all over Europe. All of our products are manufactured in our factories in Austria and Germany. Froling's extensive service network ensures that we can handle all enquiries quickly.

GUARANTEED QUALITY AND RELIABILITY FROM AUSTRIA

- International pioneer in technology and design
- Sophisticated fully automatic operation
- Excellent environmental compatibility
- Environmentally responsible energy efficiency
- Renewable and CO₂-neutral fuel
- Ideal for all types of house
- Up to 5 year Froling-warranty (subject to warranty conditions)

Occupying just 0.38 m² of space, the PE1 Pellet boiler sets new standards. The new PE1 Pellet stands out for its quiet operation and ease of use, combined with low emissions and very low energy consumption. Thanks to its high energy efficiency the PE1 Pellet is particularly suitable for low-energy and passive houses.

The compact solution for the boiler room
A unique design: The new PE1 Pellet is optionally available with DHW tank block for hot water and hydraulic block with heating circuit pumps, heating circuit mixing valve and DHW tank loading. These two modules make the PE1 Pellet the compact all-round solution for the boiler room.

The „**Plus X Award**“ honours high-quality innovations that make life simpler and more enjoyable while respecting the environment. Froling's SP Dual stood out in the categories for **innovation, high quality, ease of use, functionality and ecology**.



PELLETS BOILER PE1 PELLET

Speed-controlled, quiet induced-draught fan with function monitor



Broadband lambda probe for optimal combustion

WOS system Efficiency Optimisation System

High-quality pellet burner

High-quality insulation

Automatic sliding grate for ash removal

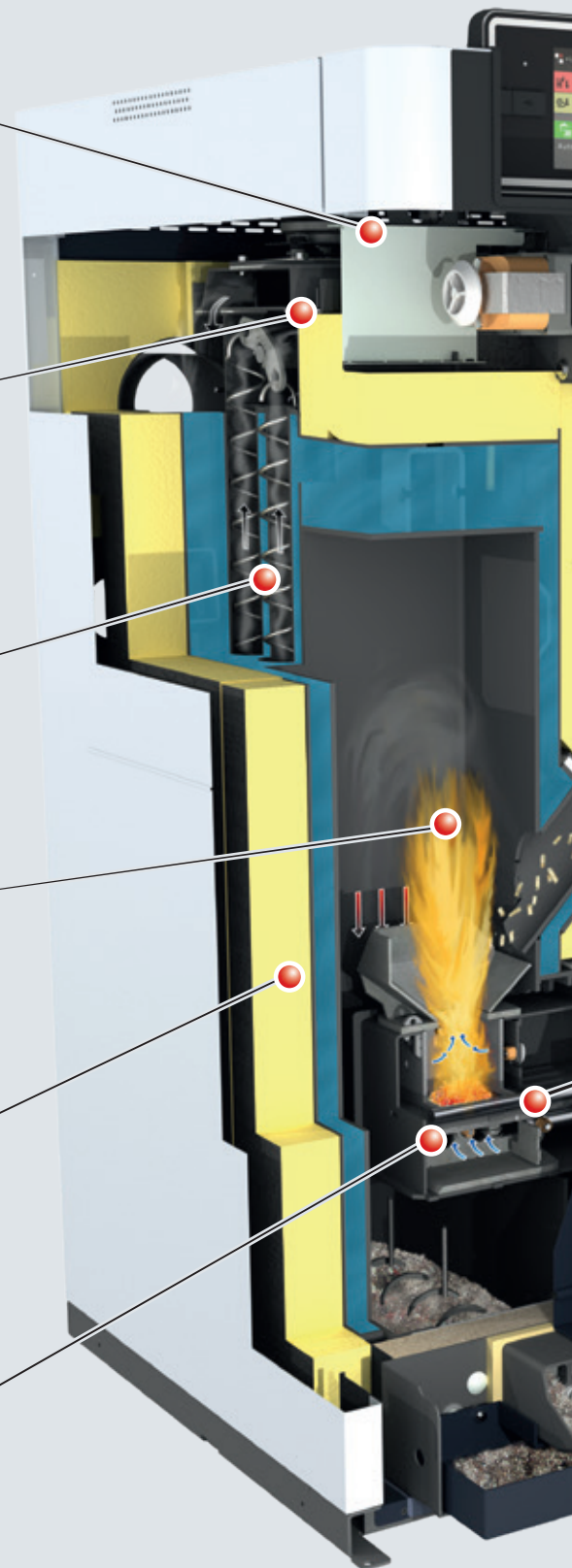

THE LATEST TECHNOLOGY

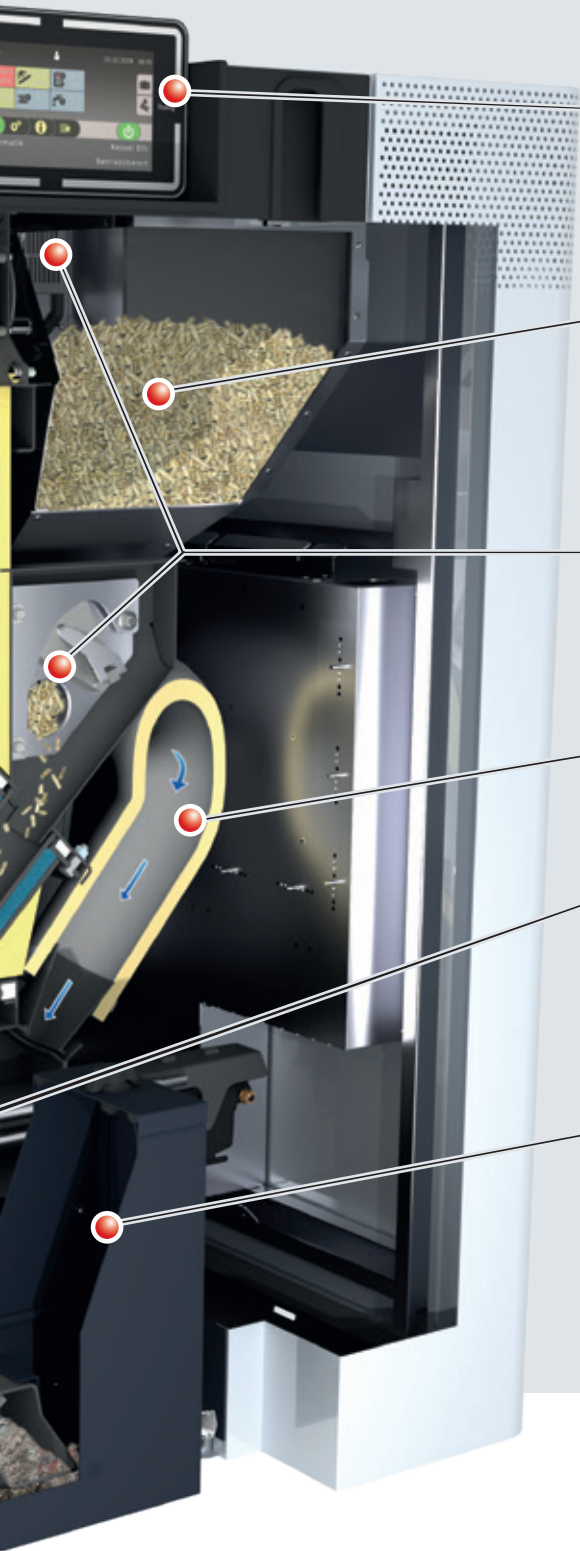

7" touch display for easy and intuitive operation

Generously dimensioned pellet container

Double protection system for maximum burn back protection

Combustion air supply (optional independent of ambient air)

Automatic ignition

Automatic ash removal in a closed ash container (Ash container volume: 13 litres with 7 - 10 kW, 28 litres with 25 - 35 kW).

Modular design

The PE1 Pellet has important advantages even before it is put into the boiler room. Thanks to its particularly compact dimensions - 60 x 64 x 120 cm (W x L x H) - assembly is child's play, even in confined boiler rooms. The PE1 Pellet boiler unit is completely insulated and wired so all you need to do is plug it in. Thanks to its modular construction, the DHW tank block and hydraulic block on the PE1 Pellet (7 - 20 kW) can be dismantled when installation space is tight and transported separately to the boiler room as individual components.

- Advantages:
- Compact design
 - Optional DHW tank block and hydraulic block



A WELL- DESIGNED INSIDE

Automatic ignition

The new glow ignition is particularly suitable for low boiler outputs. As it is operated without an additional blower fan, the glow ignition is extremely quiet and saves a lot of energy.

- Advantages:
- Quiet operation
 - Low energy consumption

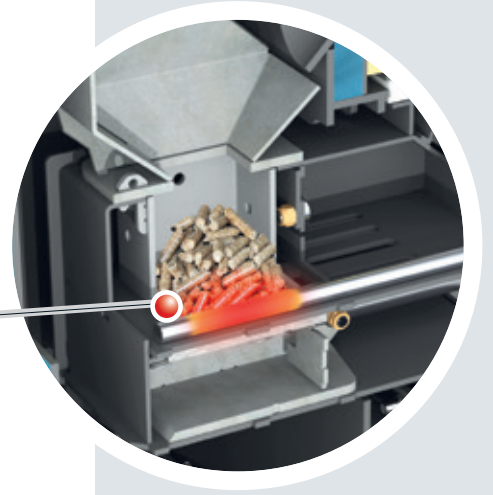

Pellet burner with automatic sliding grate

The burner is perfectly matched to the fuel pellets and their requirements and enables particularly high levels of efficiency. The sliding grate ensures automatic ash removal in the large ash drawer.

- Advantages:
- High efficiency
 - Automatic ash removal



Open sliding grate

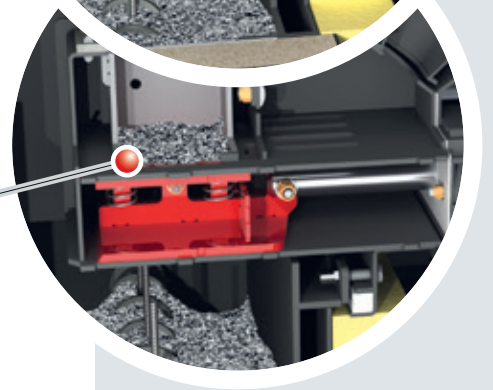

Closed sliding grate

Comfort ash removal

We never compromise on convenience. The ash that accumulates is automatically conveyed into the large ashcan where it can be easily emptied. The ash removal takes place automatically in a closed ash container by means of an ash screw.

- Advantages:
- Long emptying intervals
 - Convenient emptying

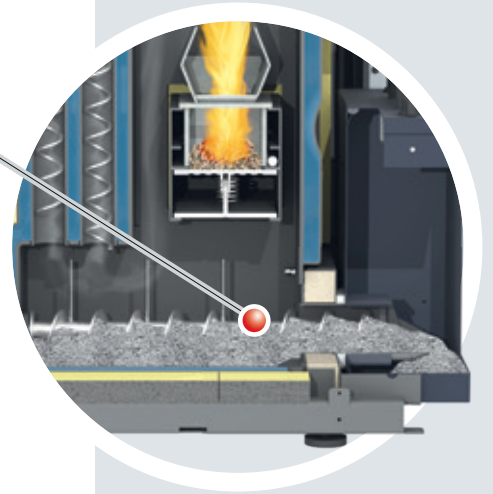



Gate valve storage room

If fuel is transported from the storage room to the pellet container, the gate valve storage room opens. The gate valve burner is closed at the same time.

Large pellet container

The large pellet container with a capacity of 32 - 76 L (depending on output size) reduces the frequency of pellet feed. The pellet container is filled fully automatically with an external suction turbine.

- Advantages:
- Easy loading
 - Efficient operation



Gate Valve Burner

In this way the double protection system ensures a reliable closure between the store and the pellet burner, guaranteeing maximum burn back protection.

Double protection system

The gate valve storage room and gate valve burner result in a double lock system and thus ensure maximum operational safety.

- Advantages:
- The highest possible operating safety
 - Maximum burn back protection

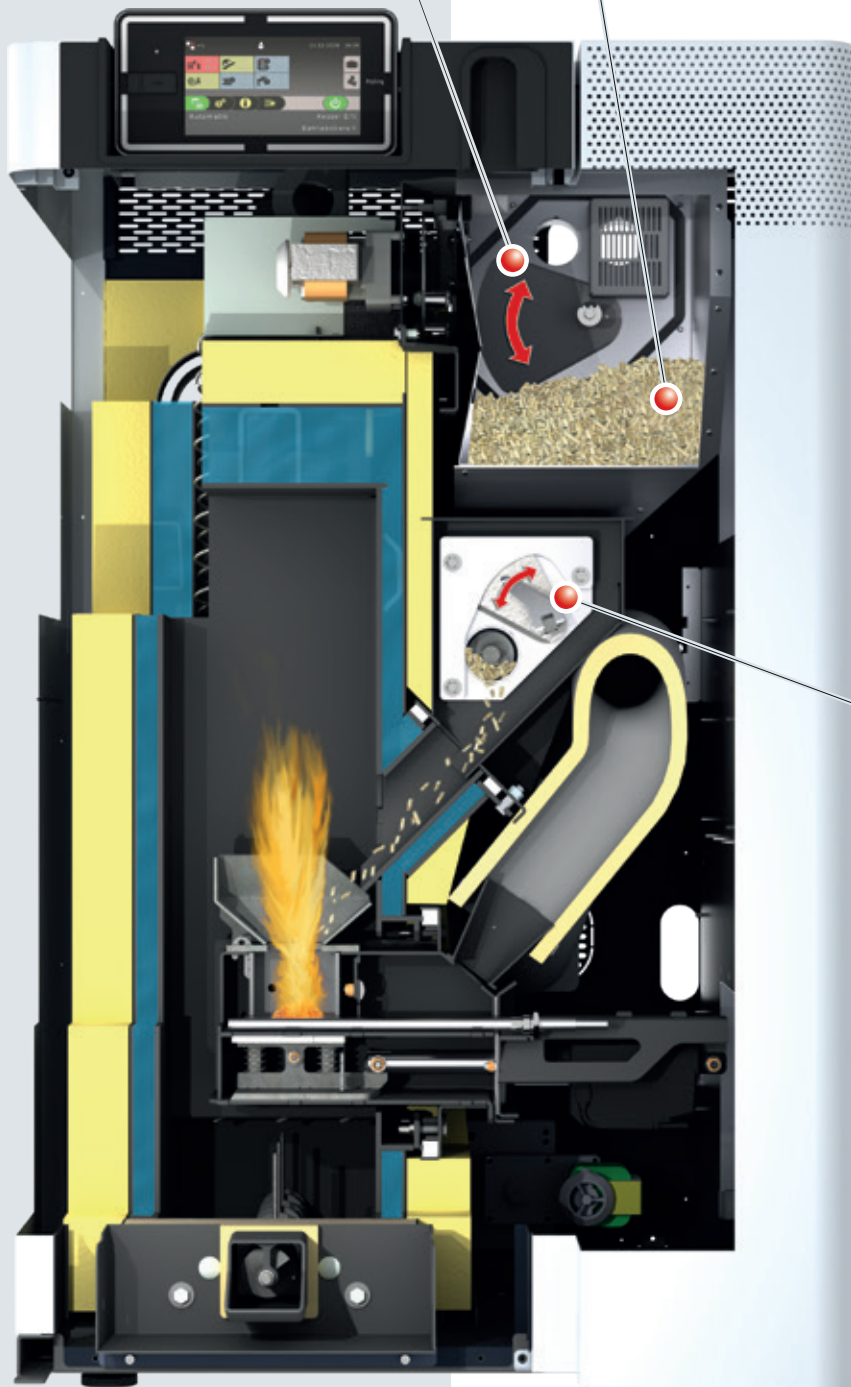

INTELLIGENT FEATURES

Speed-controlled induced draught fan and lambda control with broadband probe

The speed-regulated induced draught fan, which comes as standard, ensures the exact air quantity for combustion. As the induced draught fan is speed-regulated, it stabilises combustion throughout and adjusts the output to requirements. Working together with the lambda control, it ensures optimum combustion conditions. The induced draught fan also runs very quietly and energy efficiently.

- Advantages:
- Maximum ease of use
 - Constant optimisation of combustion

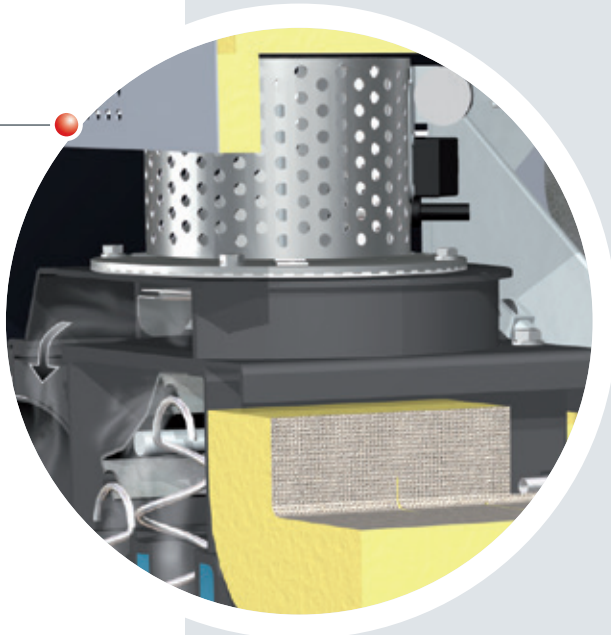

WOS system as standard

The WOS (Efficiency Optimisation System), which comes as standard, consists of special turbulators, which are placed in the heat exchanger pipes. The lever mechanism is controlled together with the double protection system. An additional benefit: clean heating surfaces ensure higher efficiency and thus lower fuel consumption.

- Advantages:
- Even greater efficiency
 - Fuel savings

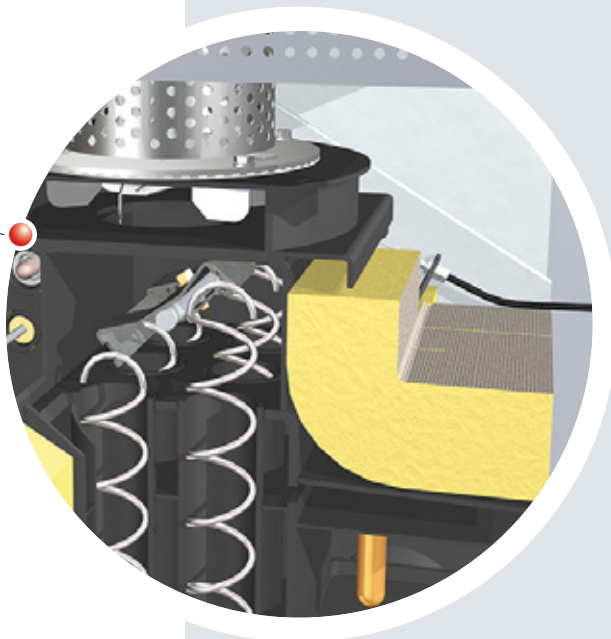

Optional DHW tank block and hydraulic block (7 - 20 kW)

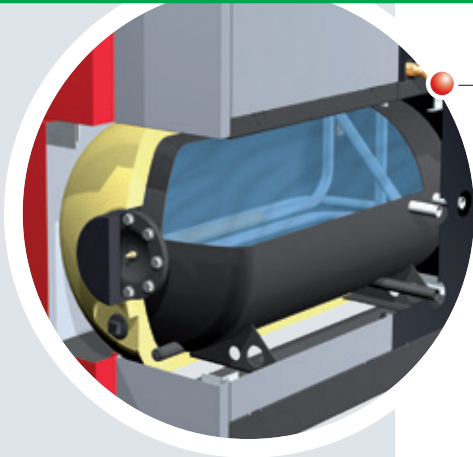

DHW tank block

The vacuum-enamelled DHW tank block has impressively compact dimensions and high-quality solid foam insulation, and with a capacity of approx. 130L, it is the ideal solution for hot water preparation. The DHW tank block also has an insulated magnesium anode and a connection for an electrical heating cartridge.

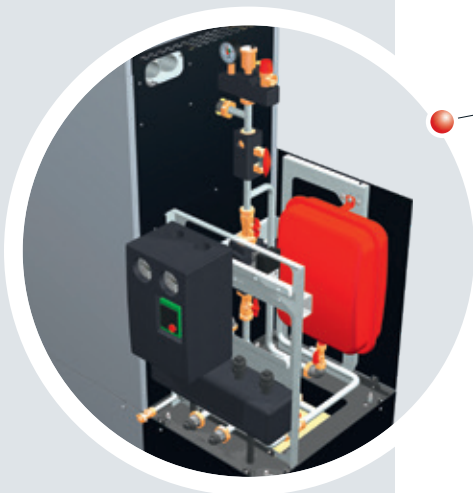

Hydraulic block

The hydraulic block contains up to two heating circuit pumps, two heating circuit mixers, an expansion tank, a line regulating valve, a safety group (with pressure gauge, quick vent valve and safety valve) and an optional loading group.

The PE1 Pellet (7 - 20 kW) is optionally available as a PE1 Pellet Unit with DHW tank block and hydraulic block.

- Advantages:**
- Optimal hot water preparation
 - Best possible heating circuit control
 - Intelligent complete solution

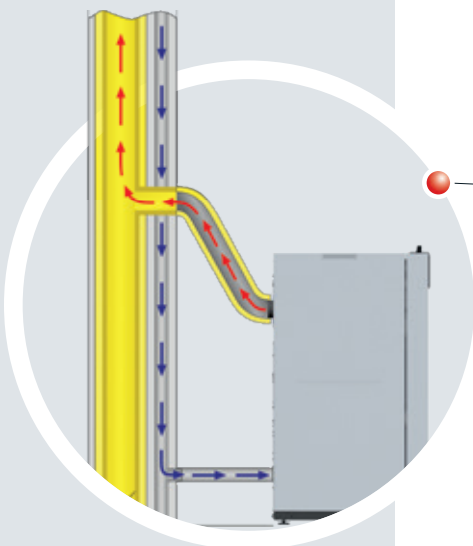

Room air-independent operation

Energy-saving houses often have a closed building shell. In traditional boiler rooms there can be uncontrolled heat loss from the necessary ventilation openings. This is avoided with room air-independent boilers because of the direct air connection. The combustion air that is fed in is also pre-heated with an integrated system, increasing the efficiency of the system.

- Advantages:**
- Perfectly suited for low-energy houses
 - Maximum efficiency

4 probe manual suction system

The RS 4 manual pellet suction system creates more space in your fuel store. Thanks to the fact that the suction probes are flexible in terms of location, it is possible to make optimal use of every room shape. The switchover between suction probes is manual. Rule of thumb: Plan for one suction probe for every 1 m² pellet storage area.

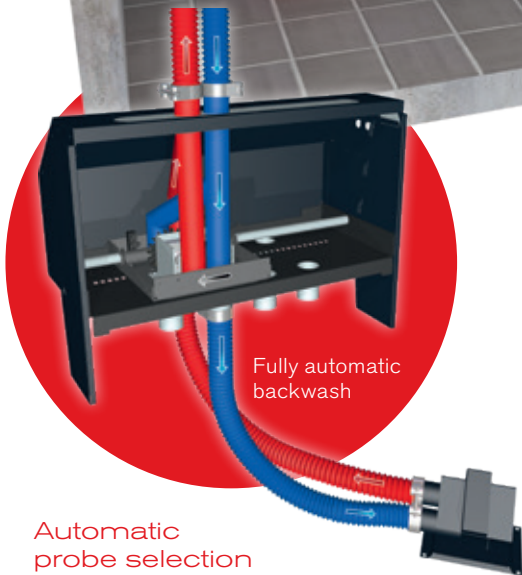

External suction module

An external suction module is used for automatic fuel feed from the fuel store to the pellet container. The suction module can be fitted in any position in the return air line.

Pellet filler pipes

The pellets are delivered by tanker and blown into the store through a filling pipe. The second pipe is used for controlled and dust free removal of the escaping air.

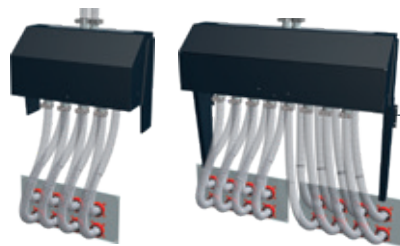

Pellet suction system RS 4 / RS 8

Design as above, however with the difference of automatic switchover between the suction probes.



Advantages at a glance:

- easy to assemble
- no sloping slides necessary in the bunker
- more store space (30%)
- automatic switching between the probes
- automatic back flushing
- maintenance-free system

More information can be found on the Froeling brochure "Discharge systems for pellets"

Bag silo

The bag silo system is a flexible, simple way of storing pellets. Available in 9 different footprints (from 1.5 m x 1.25 m to 2.9 m x 2.9 m) with a capacity of between 1.6 and 7.4 tonnes, depending on the bulk density. There are other advantages to using a bag silo. It is easy to assemble and dustproof. You can also fit rainproof and sunproof covers and install the silo outside.



Suction screw system

The Froeling screw suction system is the ideal solution for rectangular rooms with front-end removal. The deep and horizontal position of the discharge screw means the space in the room is used optimally and complete emptying of the store is guaranteed. Combined with a suction system from Froeling it also enables flexible boiler installation.



Cube 330/500S pellet supply bin

The Cube 330/500S is the optimal and most cost-effective solution for low fuel requirements. Manually filled (e.g. pellets in sacks) it can store a total of 330 kg/495 kg of pellets. The pellets are transported to the boiler by means of a suction probe, which is also included in delivery.



Pellet Mole®

This pellet discharge system is easy to install and makes full use of the store space. The Pellet Mole® draws the pellets from above, ensuring an optimum fuel feed to the boiler. The Pellet Mole moves automatically into every corner of the store to empty it as efficiently as possible.



CONDENSING TECHNOLOGY FOR PELLETT BOILERS

A variant of the Fröling PE1 Pellet boiler with innovative condensing technology is also available for power ratings from 15-35 kW. The hidden energy in flue gas which escapes unused through the chimney in conventional solutions is harnessed by an additional heat exchanger located at the rear of the boiler and fed to the heating system. This leads to more efficient operation and higher efficiencies. Already back in 1996, Fröling received the Innovation Award at the energy saving fair Wels for a calorific value application in the biomass sector, and the company is thus considered a pioneer in the field. The heat exchanger is made from high-quality stainless steel. It is cleaned via a water rinsing system. The module can be retrofitted optionally.



Advantages:

- Lower fuel costs
- Filtration of the flue gas
- Reduced emissions
- Automatic cleaning
- The condensing module can also be retrofitted at any time

Requirements for optimal use of condensing technology:

- The return temperature should be as low as possible (e.g. floor or wall heating)
- Moisture-resistant and soot-fire-resistant exhaust system (W3G approval)
- Duct connection for condensate drainage and drainage of the rinse water

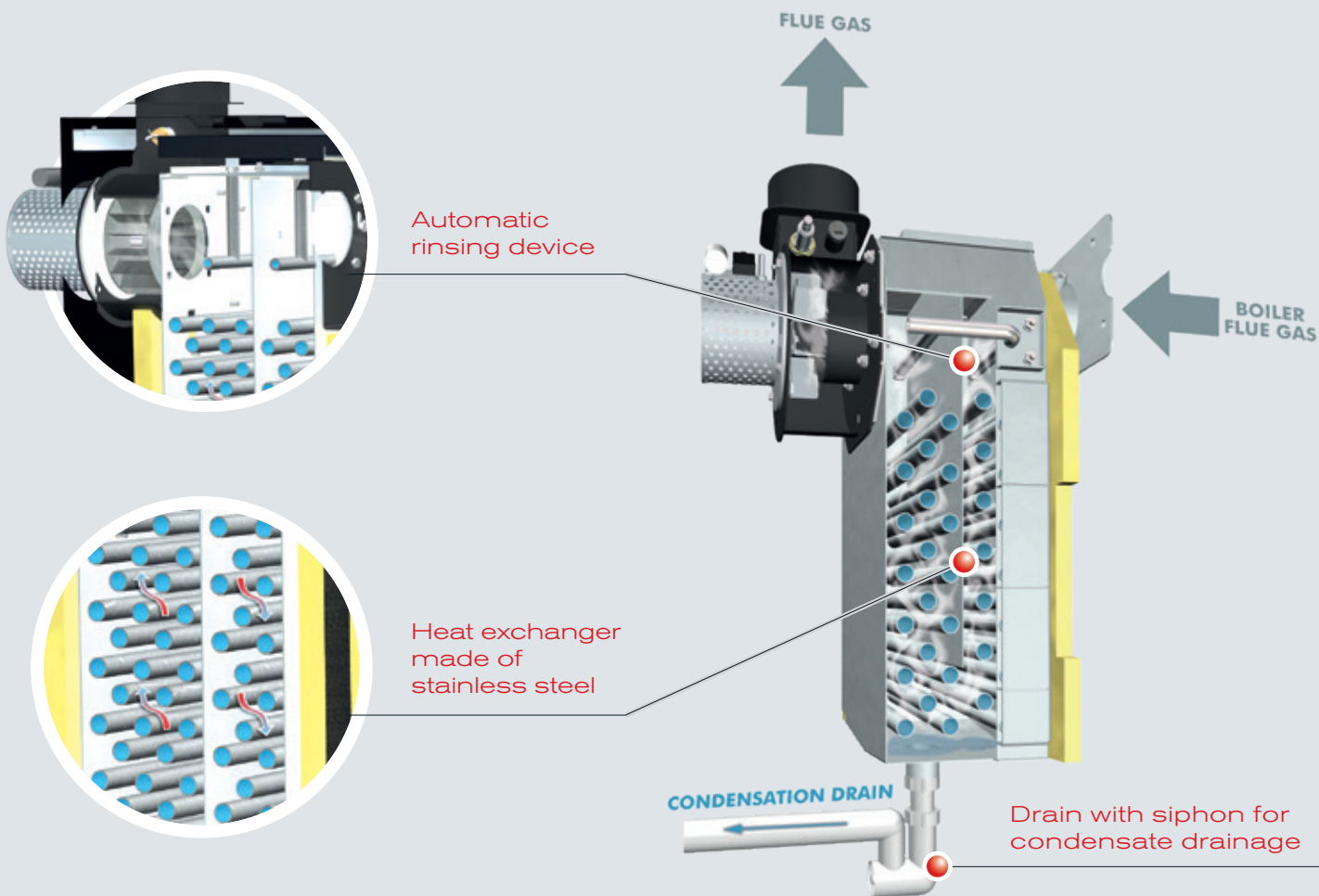

OPERATING AND MAINTENANCE AREAS

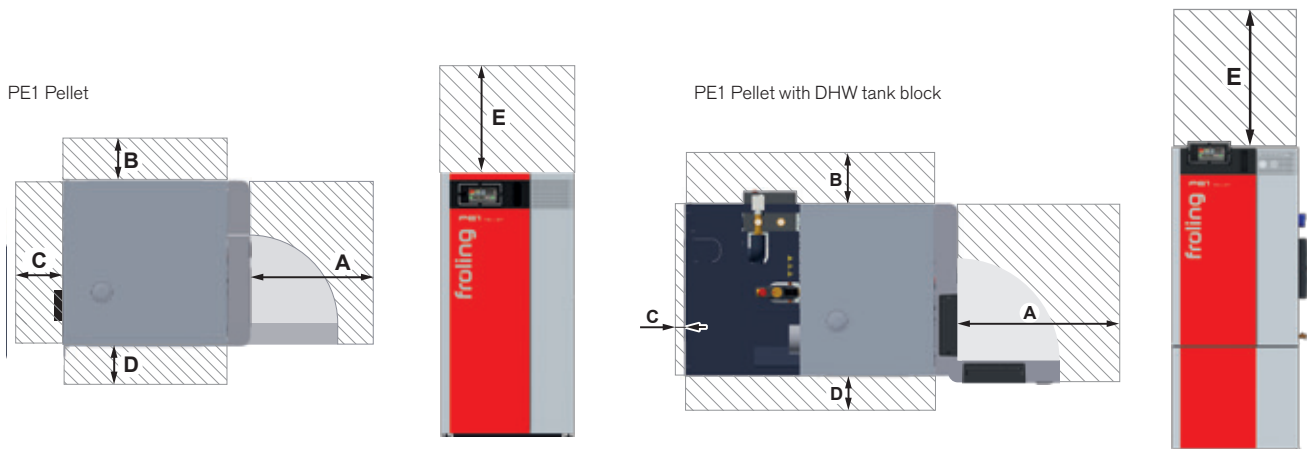

Minimum distances - PE1 Pellet [mm]	without DHW tank block and hydraulic block	with DHW tank block and hydraulic block
A Distance between insulated door and wall		600
B Distance between side of boiler and wall		300
C Distance between rear of boiler and wall	300	30
D Distance between side of boiler and wall		100
E Maintenance area above the boiler ¹		500
Minimum space (length x width) 7 - 20 kW 25 - 35 kW	1550 x 1150 1750 x 1150	1740 x 1000 -
Minimum room height 7 - 20 kW 25 - 35 kW	1800 2000	2400 -

¹ Maintenance area to expand the WOS springs upwards

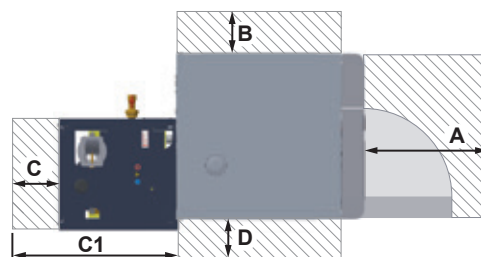

Minimum distances - PE1 Pellet with condensing technology [mm]	15 -20	25-35
A Distance from insulated door to wall		600
B Distance from boiler side to wall (control side)		300
C Space requirements including maintenance area for draft fan with condensing heat exchanger		250
C1 Space requirements for retrofitting a condensing heat exchanger	750	790
D Distance from boiler side to wall (door stop side)		100
E Maintenance area above the boiler ¹		500

¹ Maintenance area to expand the WOS springs upwards

INDIVIDUAL CONTROL UNIT OF THE HEATING SYSTEM



Lambdatronic P 3200 control unit

Froling provides a future-oriented Lambdatronic P 3200 and a new 7" touch display. Intelligent control management makes it possible to connect up to 18 heating circuits, up to 4 storage tanks and up to 8 hot water storage tanks. The control unit ensures that the operating statuses are clearly shown. The menu structure is ideally organised to allow easy operation. All essential functions can be selected by simply pressing icons on the large colour display.

- Advantages:
- Precise combustion control by a Lambda control using a Lambda probe
 - Connection for up to 18 heating circuits, 8 water heaters and up to 4 storage tank management systems
 - Integration capability for a solar panel system
 - LED frame for status display with illuminated presence detection
 - Simple and intuitive operation
 - Various smart home options (such as Loxone)
 - Remote control from the living room (remote control 3200 and RGB 3200 Touch) or via Internet (froeling-connect.com)



SIMPLE & INTUITIVE OPERATION

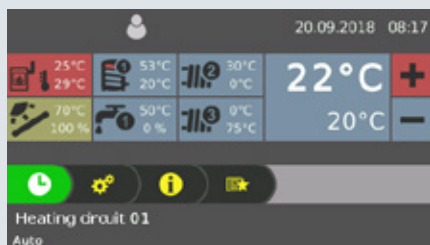

Fig. 1 General overview of the heating circuit (start screen)



Fig. 2 View of the heating times (individually adjustable)

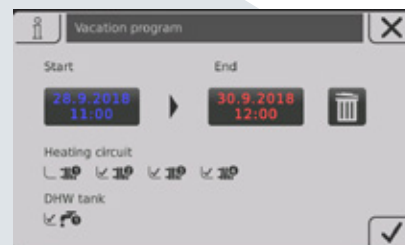

Fig. 3 Overview of the new holiday mode



KEEP TRACK OF EVERYTHING WITH THE FROLING APP

The Froling App allows you to check and control your Froling boiler online from anywhere, at any time. You can read and modify the main status information and settings easily and conveniently online. You can also specify which status messages you want to be informed about via SMS or e-mail (e.g. when the ash box is to be emptied or in the event of a fault message).

Froling boiler (software core module from version V50.04 B05.16) with boiler touch display (from version V60.01 B01.34) a broadband internet connection and a tablet/smartphone with iOS or Android operating system are required. Once the boiler has been connected to the internet and activated, the system can be accessed 24/7 from anywhere using a web-enabled device (mobile, tablet, PC, etc.). The app is available in the Android Play Store and iOS App Store.

NEW! Desktop version
with even more options.



- Simple and intuitive operation of the boiler
- Status information can be called up and changed within seconds
- Individual naming of the heating circuits
- Changes of status are notified directly to the user (e.g. via e-mail or push notifications)
- No additional hardware required (such as an Internet gateway)

SMART HOME

Enjoy smart, convenient and piece-of-mind living with the Smart Home connection options from Froling.

Loxone

Combine your Froling heating system with the Loxone Miniserver and the new Froling Extension and implement individual boiler control on the basis of the single room control of the Loxone Smart Home.

Advantages: Easy operation and viewing of the heating circuit via the Loxone Miniserver, immediate notification of status changes and individual operating modes for each situation (presence, holiday, economy mode, etc.)

Modbus

Via the Froling modbus interface, the system can be integrated into a building management system.



ACCESSORIES FOR EVEN GREATER CONVENIENCE

FRA room temperature sensor

By using the FRA room temperature sensor, sized just 8x8 cm, the main modes of the corresponding heating circuit can be easily selected and adjusted. The FRA can be connected both with and without affecting the store. The adjusting wheel allows you to change the room temperature by up to $\pm 3^{\circ}\text{C}$.



RBG 3200 room console

For even more convenience you can use the RBG 3200 room console and the new RBG 3200 Touch. You can control the heating system easily from your living room. Important system data is clearly displayed and settings can be changed at the push of a button.



RBG 3200 Touch room console

The RBG 3200 Touch has an impressive touchpad interface. The menu structure means it is intuitive and easy to use. The 17x10 cm console with colour screen shows the most important functions at a glance and automatically adjusts the background lighting to the conditions. The room consoles are connected to the boiler controller using a bus cable.



Heating circuit module

With wall casing and one contact sensor as heating circuit control for up to two mixer heating circuits.



Hydraulic module

With wall casing and two immersion sensors to control one or two pumps and one isolating valve with up to six sensors.

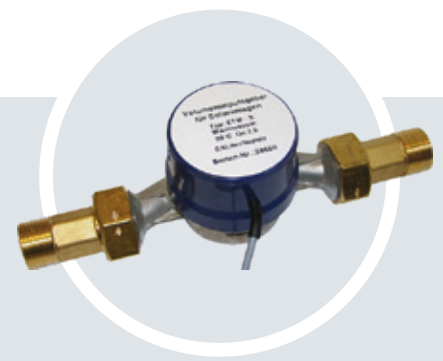

WMZ solar package kit

Set for measuring heat quantity, consisting of a volume pulse transmitter ETW-S 2.5, a collector sensor and two contact sensors for recording flow and return temperatures.

Froeling systems engineering offers efficient energy management. Up to 4 storage tanks, 8 hot water tanks and 18 heating circuits can help manage the heating. You can also benefit from the ability to integrate other means of energy production such as solar panel systems.

SYSTEMS ENGINEERING FOR OPTIMUM ENERGY CONSUMPTION

- Advantages:**
- Complete solutions for all requirements
 - The components work perfectly together
 - Integrated solar power

PE1 Pellet with H3 hygienic solar layered tank

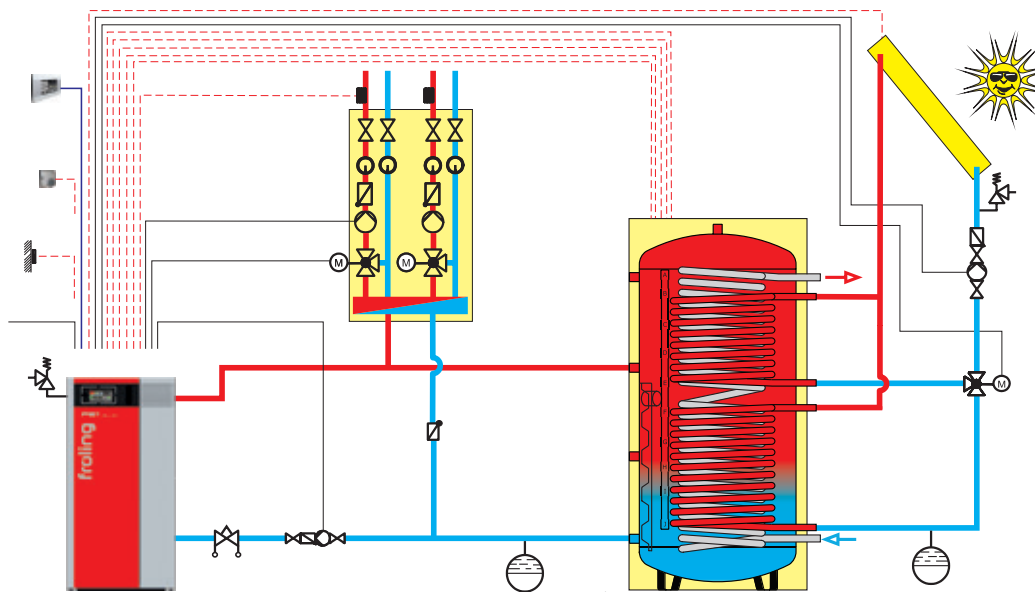

PE1 Pellet with DHW tank block and hydraulic block

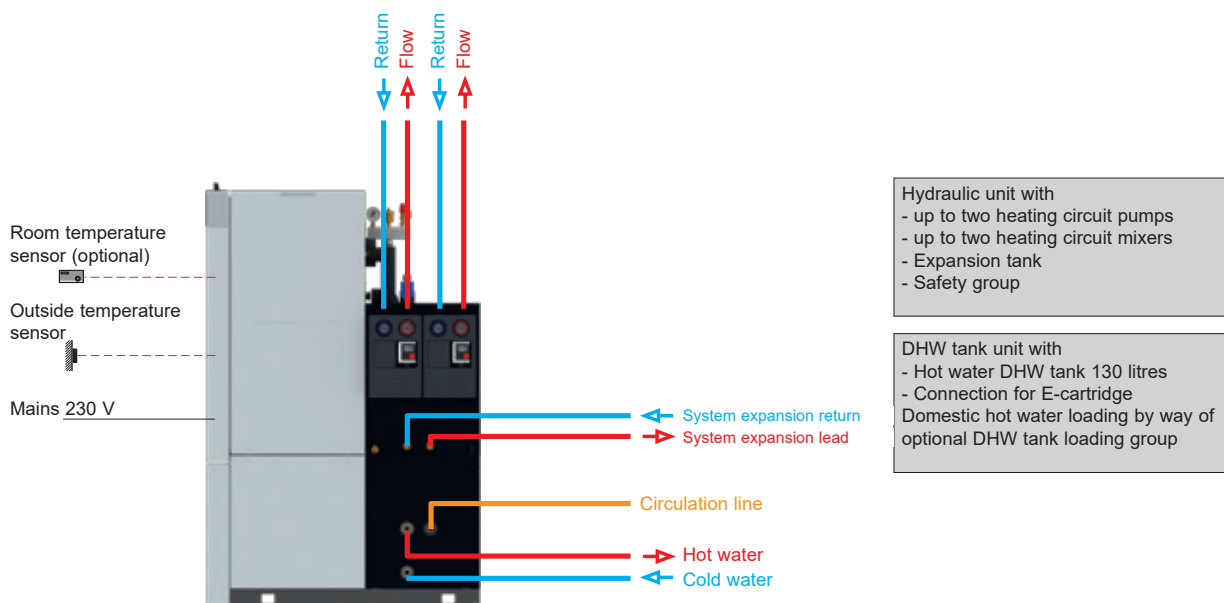

DIMENSIONS & TECHNICAL SPECIFICATIONS

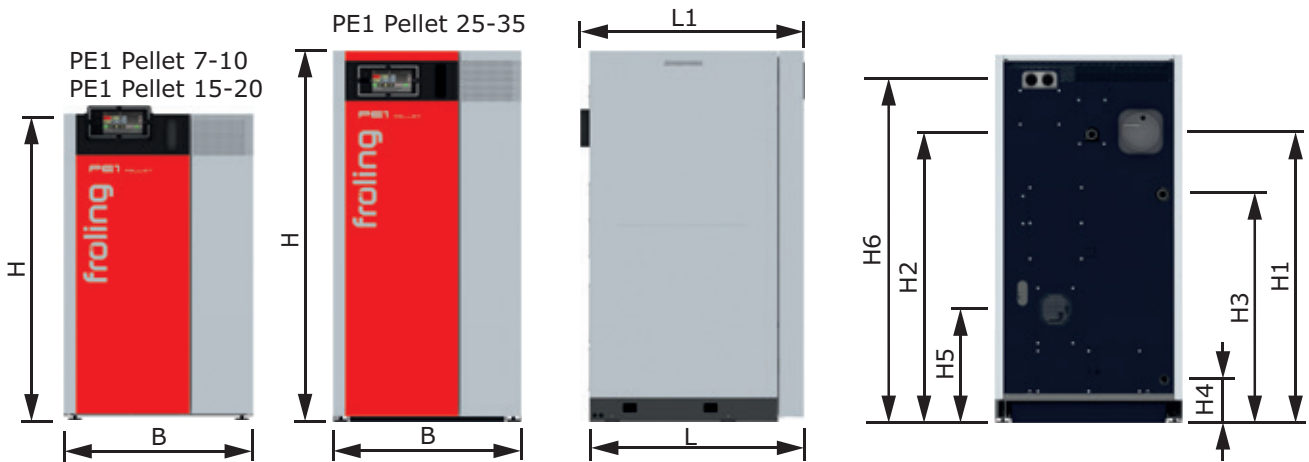

Dimension - PE1 Pellet [mm]	7 - 10	15 - 20	25 - 35
L Length of boiler	690		850
L1 Total length incl. flue pipe connection	760	740	890
B Width of boiler	650	750	
H Height, boiler	1240		1480
H1 Height, flue pipe connection	940		1170
H2 Height, flow connection	930		1160
H3 Height, return connection	750		920
H4 Height of drainage connection	95		175
H5 Height of supply air connection (for room air-independent operation)	390		460
H6 Height of suction system connection	1110		1380
Flue pipe connection	99 ¹	129	149 ¹

¹ Optional flue gas diameter of 129 mm without additional connecting adapter possible

Technical data - PE1 Pellet	7	10	15	20	25	30	35
Nominal output [kW]	7	10	15	20	25	30	35
Output range [kW]	2 - 7	2 - 10	4,5 - 15	4,5 - 20	7,2 - 25	7,2 - 30	7,2 - 35
Energy (ErP) label ¹⁾	A ⁺	A ⁺	A ⁺	A ⁺	A ⁺	A ⁺	A ⁺
Power connection [V/Hz/A]	230V / 50Hz / abgesichert C16A						
Weight [kg]	ca. 200		ca. 250		ca. 380		
Total boiler capacity (water) [l]	ca. 25		ca. 38		ca. 60		
Pellet container capacity [l]	35		41		76		
Ashcan / ash box capacity [l]	14,5		20		23		
Domestic hot water volume with optional DHW tank block [l]	122				-	-	-

¹ Composite label (boiler + controls)

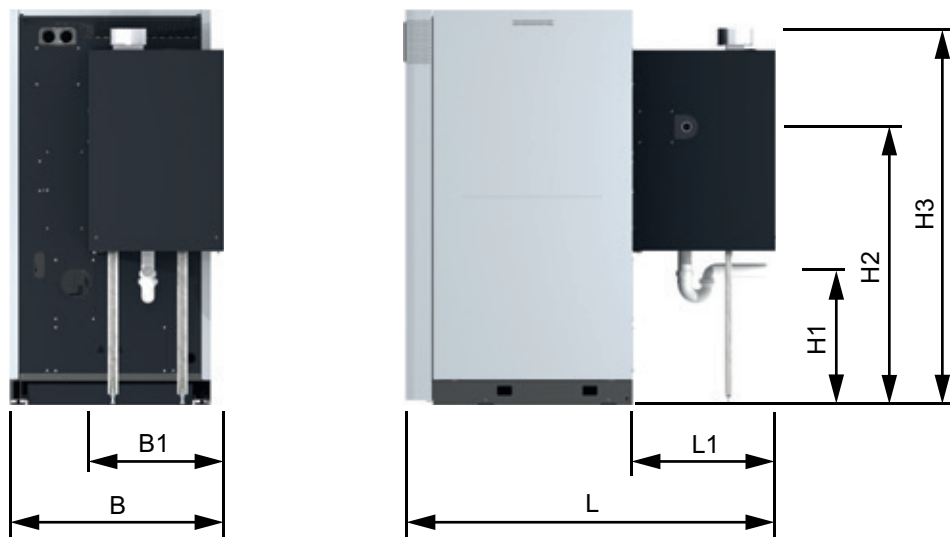

Dimensions - PE1 Pellet with condensing technology [mm]	15	20	25	30	35
L Length of boiler with condensing heat exchanger	1185			1385	
L1 Length of condensing heat exchanger	495			535	
B Total width of boiler incl. condensing heat exchanger			800		
B1 Width of condensing heat exchanger	590			615	
H1 Height of condensate drain connection	150 - 320			480 - 590	
H2 Height of return connection	809			1045	
H3 Height of exhaust pipe connection	1175			1410	
Exhaust pipe connection (inner diameter)			132		

Technical data - PE1 Pellet with condensing technology	15	20	25	30	35
Nominal heat output [kW]	16,3	21,6	27,5	32	38
Output range [kW]	4,8 - 16,3	6,4 - 21,6	8,2 - 27,5	9,6 - 32,0	11,4 - 38,0
Electrical connection [V/Hz/A]	230V / 50Hz / abgesichert C16A				
Electrical power [W]	49	57		63	67
Water content of condensing heat exchanger [l]			9		
Weight condensing heat exchanger [kg]		85		90	
Energy label PE1 Pellet ¹	A ⁺⁺	A ⁺⁺	A ⁺⁺	A ⁺⁺	A ⁺⁺

¹ Configuration label (boiler + control + calorific value)

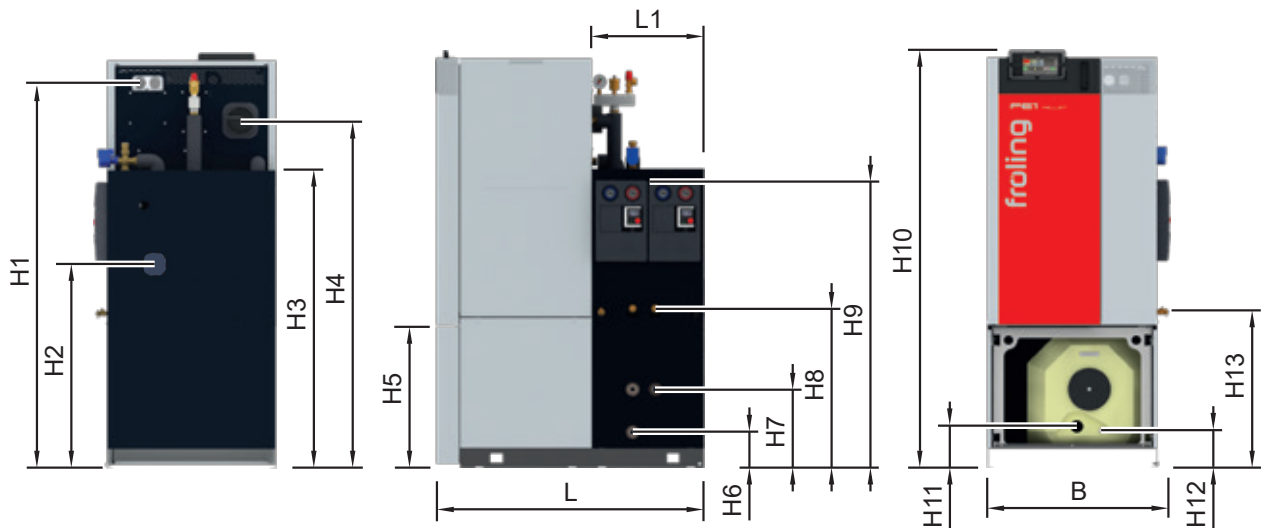

Dimensions - PE1 Pellet with DHW tank block and hydraulic block [mm]		7 - 10	15 - 20
L	Length, PE1 Pellet Unit		1150
L1	Length, hydraulic unit		500
B	Width, PE1 Pellet Unit	660	810
H1	Height of suction system connection		1720
H2	Height, supply air connection (for room airindependent operation)	980	970
H3	Height, hydraulic unit		1330
H4	Height, flue pipe connection	1570	1550
H5	Height, DHW tank unit		630
H6	Height, cold water supply of the boiler		160
H7	Height, hot water/circulation connection of the boiler		350
H8	Height of flow/return connection of the boiler		710
H9	Height of flow/return connection of the heating circuits		1260
H10	Height, PE1 Pellet Unit		1810
H11	Height, electronic heating cartridge connection		185
H12	Height, drainage connection of DHW tank		165
H13	Height of the drainage connection of the boiler		690

The ecodesign requirements according to VO (EU) 2015/1189, Annex II, point 1. are met.

Your Froling partner

Froeling Heizkessel- und Behälterbau Ges.m.b.H.
A-4710 Grieskirchen, Industriestr. 12

AT: Tel +43 (0) 7248 606-0
Fax +43 (0) 7248 606-600

DE: Tel +49 (0) 89 927 926-0
Fax +49 (0) 89 927 926-219

E-mail: info@froeling.com
Web: www.froeling.com